

MAGNOMATIC

THERMA TOUR 600



User Manual

US SKU#:
UPC#:

TST613
810008261491

©2023 **MAGMATIC EFFECTS** all rights reserved. Information, specifications, diagrams, images, and instructions herein are subject to change without notice. **MAGMATIC EFFECTS** logo and identifying product names and numbers herein are trademarks of **MAGMATIC EFFECTS**. Copyright protection claimed includes all forms and matters of copyrightable materials and information now allowed by statutory or judicial law or hereinafter granted. Product names used in this document may be trademarks or registered trademarks of their respective companies and are hereby acknowledged. All non-MAGMATIC brands and product names are trademarks or registered trademarks of their respective companies.

MAGMATIC EFFECTS and all affiliated companies hereby disclaim any and all liabilities for property, equipment, building, and electrical damages, injuries to any persons, and direct or indirect economic loss associated with the use or reliance of any information contained within this document, and/or as a result of the improper, unsafe, insufficient and negligent assembly, installation, rigging, and operation of this product.

MAGMATIC EFFECTS | 6122 S. Eastern Ave. | Los Angeles, CA. 90040
 323-582-3322 | 323-832-9142 fax | www.elationlighting.com | sales@magmaticeffects.com

Elation Professional B.V. | Junostraat 2 | 6468 EW Kerkrade, The Netherlands
 +31 45 546 85 66 | +31 45 546 85 96 fax | www.elationlighting.eu | info@elationlighting.eu

Elation Professional Mexico | AC Santa Ana 30 | Parque Industrial Lerma, Lerma, Mexico 52000
 +52 (728) 282-7070

DOCUMENT VERSION

Due to additional product features and/or enhancements, an updated version of this document may be available online. Please check www.elationlighting.com for the latest revision/update of this manual before beginning installation and/or programming.

Date	Document Version	Software Version ≥	DMX Channel Mode	Notes
09/02/20	1.0	1.0	1 / 3 Channels	Initial Release
12/07/20	1.1	N/C	No Change	Updated Voltage Specs
02/09/21	1.2	N/C	No Change	Updated Dimensional Drawings & Specifications
06/06/22	1.3	N/C	No Change	Updated System Menu
09/01/22	1.4	N/C	No Change	Updated Cleaning & Maintenance
11/17/22	1.5	N/C	No Change	Added RDM information
01/18/23	1.6	N/C	No Change	Updated Specifications
02/09/23	1.7	N/C	No Change	Updated Overview
02/15/23	1.8	N/C	No Change	Added Remote Control

CONTENTS

General Information	4
Limited Warranty (USA Only)	5
Warranty Returns (USA Only)	6
Safety Guidelines	7
Overview	9
Set Up	10
Remote Control	11
Control Panel	12
System Menu	13
Preset Mode	17
DMX Channel Functions & Values	18
Remote Device Management (RDM)	19
Dimensional Drawings	20
Trouble Shooting Cleaning & Maintenance	21
Specifications	22

GENERAL INFORMATION

INTRODUCTION

Please read and understand the instructions in this manual carefully and thoroughly before attempting to operate this device. These instructions contain important safety and use information. **This product is intended to be used by professionally trained personnel only, and is not suitable for private use.**

UNPACKING

Every device has been thoroughly tested and has been shipped in perfect operating condition. Carefully check the shipping carton for damage that may have occurred during shipping. If the carton is damaged, carefully inspect the device for damage, and be sure all accessories necessary to install and operate the device have arrived intact. In the event that damage has been found or parts are missing, please contact our customer support team for further instructions. Please do not return this device to your dealer without first contacting customer support. Please do not discard the shipping carton in the trash. Please recycle whenever possible.

BOX CONTENTS

Twist-locking power cable

CUSTOMER SUPPORT

Contact **MAGMATIC** customer service for any product related service and support needs. Also visit forums.elationlighting.com with questions, comments, or suggestions.

ELATION SERVICE USA - Monday - Friday 8:00am to 4:30pm PST
323-582-3322 | Fax 323-832-9142 | sales@magmaticeffects.com

ELATION SERVICE EUROPE - Monday - Friday 08:30 to 17:00 CET
Voice: +31 45 546 85 63 | Fax: +31 45 546 85 96 | support@elationlighting.eu

REPLACEMENT PARTS: Please visit parts.elationlighting.com



IMPORTANT NOTICE!

THERE ARE NO USER SERVICEABLE PARTS INSIDE THIS UNIT. DO NOT ATTEMPT ANY REPAIRS YOURSELF. DOING SO WILL VOID YOUR MANUFACTURER'S WARRANTY. DAMAGES RESULTING FROM MODIFICATIONS TO THIS FIXTURE AND/OR THE DISREGARD OF SAFETY INSTRUCTIONS AND GUIDELINES IN THIS MANUAL VOID THE MANUFACTURER'S WARRANTY AND ARE NOT SUBJECT TO ANY WARRANTY CLAIMS AND/OR REPAIRS.

NEVER POINT OR AIM A FOG MACHINE TOWARD PEOPLE OR THEIR CLOTHING. THIS UNIT EMITS HOT VAPOR AND SHOULD BE USED WITH THE SAME CARE THAT YOU WOULD OBSERVE WHEN USING AN ELECTRIC KETTLE OR IRON.

LIMITED WARRANTY (USA ONLY)

A. Magmatic Effects hereby warrants, to the original purchaser, Magmatic products to be free of manufacturing defects in material and workmanship for a period of two years (730 days) from the original date of purchase. This warranty excludes discharge lamps and all product accessories. This warranty shall be valid only if the product is purchased within the United States of America, including possessions and territories. It is the owner's responsibility to establish the date and place of purchase by acceptable evidence, at the time service is sought.

B. For warranty service, send the product only to the Magmatic Effects factory. All shipping charges must be pre-paid. If the requested repairs or service (including parts replacement) are within the terms of this warranty, Magmatic Effects will pay return shipping charges only to a designated point within the United States. If any product is sent, it must be shipped in its original package and packaging material. No accessories should be shipped with the product. If any accessories are shipped with the product, Magmatic Effects shall have no liability what so ever for loss and/or damage to any such accessories, nor for the safe return thereof.

C. This warranty is void if the product serial number and/or labels are altered or removed; if the product is modified in any manner which Magmatic Effects concludes, after inspection, affects the reliability of the product; if the product has been repaired or serviced by anyone other than the Magmatic Effects factory unless prior written authorization was issued to purchaser by Magmatic Effects; if the product is damaged because not properly maintained as set forth in the product instructions, guidelines and/or user manual.

D. This is not a service contract, and this warranty does not include any maintenance, cleaning or periodic check-up. During the periods as specified above, Magmatic Effects will replace defective parts at its expense, and will absorb all expenses for warranty service and repair labor by reason of defects in material or workmanship. The sole responsibility of Magmatic Effects under this warranty shall be limited to the repair of the product, or replacement thereof, including parts, at the sole discretion of Magmatic Effects. All products covered by this warranty were manufactured after January 1, 1990, and bear identifying marks to that effect.

E. Magmatic Effects reserves the right to make changes in design and/or performance improvements upon its products without any obligation to include these changes in any products theretofore manufactured.

F. No warranty, whether expressed or implied, is given or made with respect to any accessory supplied with the products described above. Except to the extent prohibited by applicable law, all implied warranties made by Magmatic Effects in connection with this product, including warranties of merchantability or fitness, are limited in duration to the warranty periods set forth above. And no warranties, whether expressed or implied, including warranties of merchantability or fitness, shall apply to this product after said periods have expired. The consumer's and/or dealer's sole remedy shall be such repair or replacement as is expressly provided above; and under no circumstances shall Magmatic Effects be liable for any loss and/or damage, direct and/or consequential, arising out of the use of, and/or the inability to use, this product.

G. This warranty is the only written warranty applicable to Magmatic Effects products and supersedes all prior warranties and written descriptions of warranty terms and conditions heretofore published.

WARRANTY RETURNS (USA ONLY)

To obtain warranty service, a Return Material Authorization (RMA) number must first be obtained from MAGMATIC. It is the Customer's responsibility to provide product proof of purchase and serial number by acceptable evidence such as an invoice copy or an approved MAGMATIC Extended Warranty Certificate ("EWC") and any relevant maintenance records at the time warranty service is sought. Failure to provide acceptable evidence of product proof of purchase or EWC and any relevant maintenance records may be cause for denial of warranty service.

Products returned for warranty service must be sent without any accessories (i.e., power, data, and safety cables, brackets, clamps, rigging hardware, frost filters, gel frames, barn doors, lenses, hoses, nozzles, rack mounting hardware, etc.), must be boxed using the original and/or suitable packaging materials (double-box and foam) that provides ample product protection for ground and/or air freight transit, and must be shipped freight pre-paid and insured to MAGMATIC in Los Angeles, CA or a MAGMATIC Authorized Service Center. The RMA number must be clearly written on the outside of the return box, and a brief description of the problem and the RMA number must be documented and included in the box.

Products returned for warranty service without an RMA number clearly marked on the outside of the package will be refused and returned to the shipper at the Customer's expense. Products returned for warranty service, which are received damaged due to inadequate and/or improper packaging and/or due to damage caused by the shipping carrier, may incur additional repair charges before warranty service begins and/or may void this warranty. If any product accessories (included and/or optional) are shipped with the product, MAGMATIC and/or the MAGMATIC Authorized Service Center shall have no liability what so ever for the loss and/or damage to any such accessories, nor the safe return thereof. If the requested warranty repairs or service (including parts replacement) are within the terms of this warranty, MAGMATIC will pay return ground transportation shipping charges to a single designated point within the United States.

SAFETY GUIDELINES

This fixture is a sophisticated piece of electronic equipment. To guarantee smooth operation, it is important to follow all instructions and guidelines in this manual. Magmatic Effects is not responsible for injury and/or damages resulting from the misuse of this fixture due to the disregard of the information printed in this manual. Only qualified and/or certified personnel should perform installation of this fixture and only the original rigging parts included with this fixture should be used for installation. Any modifications to the fixture and/or the included mounting hardware will void the original manufacturer's warranty and increase the risk of damage and/or personal injury.



PROTECTION CLASS 1 - FIXTURE MUST BE PROPERLY GROUNDED.



THERE ARE NO USER SERVICEABLE PARTS INSIDE THIS UNIT. DO NOT ATTEMPT ANY REPAIRS YOURSELF. DOING SO WILL VOID YOUR MANUFACTURER'S WARRANTY. DAMAGES RESULTING FROM MODIFICATIONS TO THIS DEVICE AND/OR THE DISREGARD OF SAFETY INSTRUCTIONS AND GUIDELINES IN THIS MANUAL VOID THE MANUFACTURER'S WARRANTY AND ARE NOT SUBJECT TO ANY WARRANTY CLAIMS AND/OR REPAIRS.



THERE ARE NO USER SERVICEABLE PARTS INSIDE THIS UNIT. DO NOT ATTEMPT ANY REPAIRS YOURSELF. DOING SO WILL VOID YOUR MANUFACTURER'S WARRANTY. DAMAGES RESULTING FROM MODIFICATIONS TO THIS DEVICE AND/OR THE DISREGARD OF SAFETY INSTRUCTIONS AND GUIDELINES IN THIS MANUAL VOID THE MANUFACTURER'S WARRANTY AND ARE NOT SUBJECT TO ANY WARRANTY CLAIMS AND/OR REPAIRS.



**FOR USE IN INDOOR / DRY LOCATIONS ONLY
DO NOT EXPOSE DEVICE TO RAIN AND/OR MOISTURE
PLACE UNIT IN A WELL VENTILATED AREA
ALLOW 40" (100CM) ABOVE AND AROUND THE UNIT FOR PROPER VENTILATION.**

SAFETY GUIDELINES

- **CAUTION: Fog machines may set off smoke alarms!**
- Do not attempt installation and/or operation of this device without proper knowledge of how to do so.
- Do not point or direct fog output in an unsafe direction.
- Do not touch the front nozzle while the machine is in operation, or immediately after the device has been shut down, as the nozzle may get hot during operation.
- Do not shake device, and avoid brute force when installing and/or operating.
- Be sure to save the packing carton in the unlikely event the device may have to be returned for service.
- Do not spill water or other liquids into or on to the device. Be sure that all the fog fluid is kept inside the fluid reservoir.
- Be sure that the local power outlet matches the required voltage for the device.
- Do not remove components or disassemble the device. There are no user-serviceable parts inside.
- Never connect this device to a dimmer pack.
- Do not attempt to operate this device if it has been damaged in any way.
- Never use this device with the cover removed.
- To reduce risk of electrical shock or fire, do not expose this device to rain or moisture.
- Do not attempt to operate this device if the power cord has been frayed, crimped, and/or damaged. Replace any damaged power cords with new cords of the same power rating.
- Do not remove or break off the ground prong from the electrical cord. This prong is used to reduce the risk of electrical shock and fire in case of an internal short.
- Always disconnect from main power before making any connection, performing cleaning or maintenance, or adding or draining water.
- Always drain fluid before moving the device.
- Always be sure to mount this device in an area that will allow proper ventilation.
- Always disconnect power cords during long periods of non-use.
- This unit is intended for indoor use only. Use of this product outdoors voids all warranties.
- Always mount this unit in a safe and stable matter.
- Please route your power cord out of the way of foot traffic. Power cords should be routed so they are not likely to be walked on, or pinched by items placed upon or against them.
- The device should be serviced by qualified service personnel when:
 - The power cords or plugs have become damaged.
 - Objects have fallen on and/or liquid has spilled into the device.
 - The device has been exposed to rain and/or moisture.
 - The device does not operate normally or exhibits a marked change in performance.

OVERVIEW

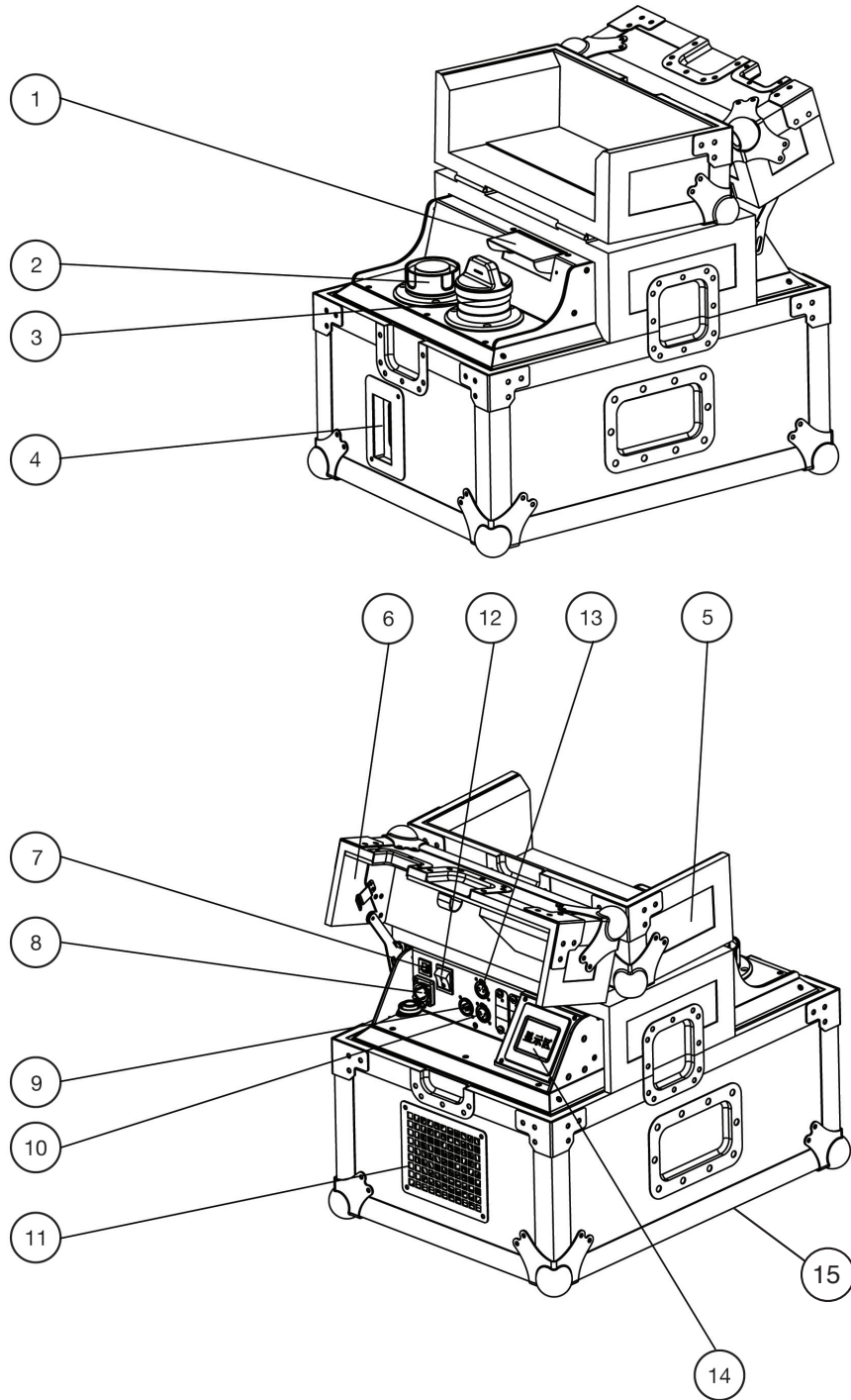

- 1. Directional Blower
- 2. Tank
- 3. Haze Outlet w/ Cap
- 4. Tank Level Gauge
- 5. Haze Outlet/Filler Lid
- 6. Control Panel Lid
- 7. Breaker
- 8. Power Input

- 9. DMX Input
- 10. DMX Output
- 11. Cooling Vent
- 12. Power Switch
- 13. Wired Remote Port
- 14. Touch Display Screen
- 15. Fluid Drain Valve
(on underside)

SETUP

1. Open the shipping carton and carefully remove the device from the shipping carton.
2. Be sure to remove ALL the packing material, paying particular attention to the area around the fog outlet vent.
3. Set the device on a flat dry surface. Open the filler/outlet lid and unscrew the tank filler cap.
4. Fill the reservoir with **MAGMATIC ATMOSITY fluid (SKU# ARH and AAH) only**, and replace the reservoir cap. Never run the device on anything other than an approved, MAGMATIC branded fluid, as doing so can result in severe damage to your device.
5. Plug the device into a matching power supply and flip the power switch to the ON position.
6. After power is switched on, the device is immediately ready to emit haze. The device may be controlled manually or via DMX signal.

REMOTE CONTROL

This unit can be operated using the **MagRemote VIDI** remote control, which is a 4-pin, wired remote that can be used to control the volume, intensity, duration, and interval. Please note that the MagRemote VIDI is a universal remote, and some remote functions may not be applicable to all units.

To operate the device using this remote, simply connect the remote's 4-pin male connector to the matching 4-pin female port on the back of the unit, which is labeled "Remote In." The unit will automatically recognize whether or not the remote has been connected. Available functions are listed below:

Manual Button - Unit outputs when button is pressed, and stops when the button is released. LED illuminates when unit is outputting.

Continuous Button - Unit outputs when button is pressed the first time, and continues to output until the button is pressed again. LED illuminates when unit is outputting.

Timer On/Off Button - Activates or deactivates the timer function. Timer function is adjustable using the interval and duration knobs. LED illuminates when function is activated.

Volume Knob - N/A.

Intensity Knob - N/A.

Interval Knob - Adjust the length of the time that the unit will take before it begins to output haze.

Duration Knob - Adjust the length of time that the unit will produce haze once the unit reaches the current interval time.



CONTROL PANEL



This fixture includes a system menu with an easy to navigate touch screen control panel where all necessary settings and adjustments are made. When first powering on the fixture, the fixture’s main menu will be displayed (**see Main Menu Screen below**).

Press the main menu icon you would like to access. Use the **ENTER** button to access sub menus and use the **UP** and **DOWN** buttons to make adjustments. Press the **ENTER** button to confirm your adjustments. You may exit the main menu at any time without making any adjustments by pressing the **BACK/EXIT** button.

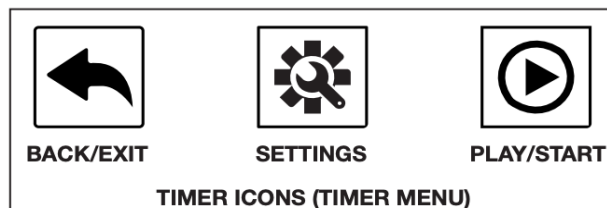
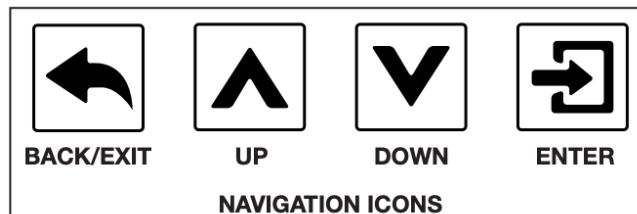
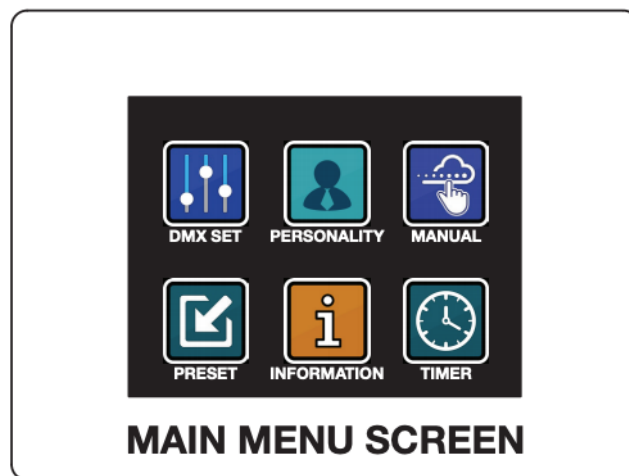
After 10 seconds of non-operation, the system will return to the “Ready to Fog” status screen.











SYSTEM MENU

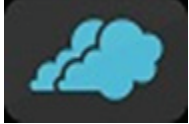

 DMX SET	DMX Addr	1 - 512		Set DMX address
	DMX Mode	1-CH		Set DMX mode
3-CH				
 PERSONALITY	Wifi Set*	Wifi Name	0 - xxxxx	Displays name of Wifi connection
		Wifi Passcode	00000000 - 00009999	First 4 digits of passcode must be "0000"
		Wifi IP	0~255 . 0~255 . 0~255 . 0~255	Wifi IP address
		Wifi Port	0 - 65535	Network port
		Reset Network	Complete	Wifi paired successfully within 5s
			Failed, try again	Wifi not paired within 5s
	Wifi -> DMX & Magfly	On / Off	Enable/disable APP data to be converted to DMX data and sent out via DMX port and EFly. Please switch off when not in use.	
	LCD Set	Screen Off	Never	Screen switches off after designated period of inactivity
			10s	
			40s	
			1min	
			2min	
			5min	
			10min	
	20min			
Magfly Set*	Magfly Channel	0 - 14	Magfly channel setting	
	Magfly	On / Off	Magfly switch	
MagRF Learn*	Connected		Frequency matching successful within 20s	
	Connection Failed		Frequency matching not successful within 20s	

CONTINUED ON NEXT PAGE

SYSTEM MENU

 PERSONALITY (continued)	Last State	Yes / No	Define whether device stays at the last step
	Default	Yes / No	Restore device to default factory settings
 MANUAL	 Fog (100%)		 Start or stop using the triangle icon. Note that both Fog and Wind are fixed at 100%
	 Wind (100%)		
 TIMER	Interval	0s - 2500s	 Start or stop using the triangle icon. Note that both Fog and Wind are fixed at 100%
	Duration	0s - 250s	
 PRESET	Preset 1: Duration: 40min Interval: 20min Fog: 100% Wind: 100%		 Start or stop using the triangle icon. Note that both Fog and Wind are fixed at 100%
	Preset 2: Duration: 30min Interval: 15min Fog: 100% Wind: 100%		
	Preset 3: Duration: 20min Interval: 10min Fog: 100% Wind: 100%		
CONTINUED ON NEXT PAGE			





SYSTEM MENU

 <p>PRESET (continued)</p>	<p>Preset 4: Duration: 10min Interval: 5min Fog: 100% Wind:100%</p>		 <p>Start or stop using the triangle icon. Note that both Fog and Wind are fixed at 100%</p>
	<p>Preset 5: Duration: 5min Interval: 5min Fog: 100% Wind:100%</p>		
 <p>INFORMATION</p>	State	Normal / Error	Shows operational status of device
	Slot 1	Null / Magfly / Wifi / MagRF	Shows type of module fitted to slot 1; "Null" signifies no module fitted
	Slot 2	Null / Magfly / Wifi / MagRF	Shows type of module fitted to slot 2; "Null" signifies no module fitted
	Last Control	LCD_auto / LCD_manual / DMX / Wifi / MagRF / MagRemote / Error	Display current means of control
	Remote State	Yes / No	Shows whether remote is connected
	Wifi Connect	Null / Phone / Route / No	Display the type of device that Wifi has connected to; "No" signifies Wifi module not connected, and "Null" signifies that module has failed to find a device to connect to
	Wifi IP	No / 0-255, 0-255, 0-255, 0-255	Current IP address; "No" signifies Wifi module is not connected
	Magfly Ch.	0 - 14	Magfly channel
	DMX Addr	1 - 512	DMX address
	DMX Mode	1 / 3	DMX mode
	Timer Output	100%	Fixed output
	Timer Wind	100%	Fixed wind
	Timer Int	0s - 2500s	Timer interval
Timer Dur	0s - 250s	Timer duration	

SYSTEM MENU

 INFORMATION (continued)	No Fluid	Normal / Empty	Fluid level status
	LCD Ver	Vx.x	LCD version number
	Sftwr Ver	Vx.x	Software version number

***NOTE:** When the relevant module for a selected mode is not installed, selecting the mode will prompt a message that reads “Optional Module Not Installed”

MESSAGE SMALL ICONS		
	Icons displayed after inserting MagFly module	Left to right: weakest to strongest signal
	Icons displayed after inserting Wifi module	Left to right: weakest to strongest signal
	Icon displayed after inserting MagRF module	Icon appears if RF signal is present
	Icon displayed after connecting wired remote	Icon appears if remote wire is connected

PRESET MODE

Preset Mode	Duration	Interval	Fog Output	Wind Intensity
1	40 min	20 min	100%	100%
2	30 min	15 min	100%	100%
3	20 min	10 min	100%	100%
4	10 min	5 min	100%	100%
5	5 min	5 min	100%	100%



PRESET SCREEN

DMX CHANNEL FUNCTIONS & VALUES

CHANNEL		VALUES	FUNCTION
1-CH	3-CH		
1	1		Fog
		000 - 005	Off
		006 - 255	On
	2		Duration
		000 - 005	Off (0s)
		006 - 255	On, 1s - 250s (steps of 1s)
	3		Interval
		000 - 005	Off (0s)
		006 - 255	On, 10s - 2500s (steps of 10s)

REMOTE DEVICE MANAGEMENT (RDM)

NOTE: In order for RDM to work properly, RDM enabled equipment must be used throughout the entire system, including DMX data splitters and wireless systems.

Remote Device Management (RDM) is a protocol that sits on top of the DMX512 data standard for lighting, allowing the DMX systems of the device to be managed, modified, and monitored remotely (hence, remote device management). This protocol is ideal for fixtures installed in locations that are not easily accessible.

With RDM, the DMX512 system becomes bi-directional, allowing a compatible RDM enabled controller to send out a signal to devices on the wire, as well as allowing the fixture to respond (known as a GET command). The controller can then use it's SET command to modify settings that would typically have to be changed or viewed directly via the unit's display screen, including the DMX Address, DMX Channel Mode, and Temperature Sensors.

FIXTURE RDM INFORMATION:

RDM Code	Device ID	Device Model ID	Personality ID
22A6H	Elation Terma Tour 600	1C10	1 (1) 3 (2)

Please be aware that not all RDM devices support all RDM features, and therefore it is important to check beforehand to ensure that the equipment that you are considering includes all of the features that you require.

The following parameters are accessible in RDM on this device:

[0x1000] IDENTIFY_DEVICE
[0x00F0] DMX_START_ADDRESS
[0x00C0] SOFTWARE_VERSION_LABEL
[0x0060] DEVICE_INFO
[0x0080] DEVICE_MODEL_DESCRIPTION
[0x0081] MANUFACTURER_LABEL
[0x0082] DEVICE_LABEL
[0x0050] SUPPORTED_PARAMETERS
[0x00E1] DMX_PERSONALITY_DESCRIPTION
[0x00E0] DMX_PERSONALITY
[0x0200] SENSOR_DEFINITION
[0x0201] SENSOR_VALUE

DIMENSIONAL DRAWINGS

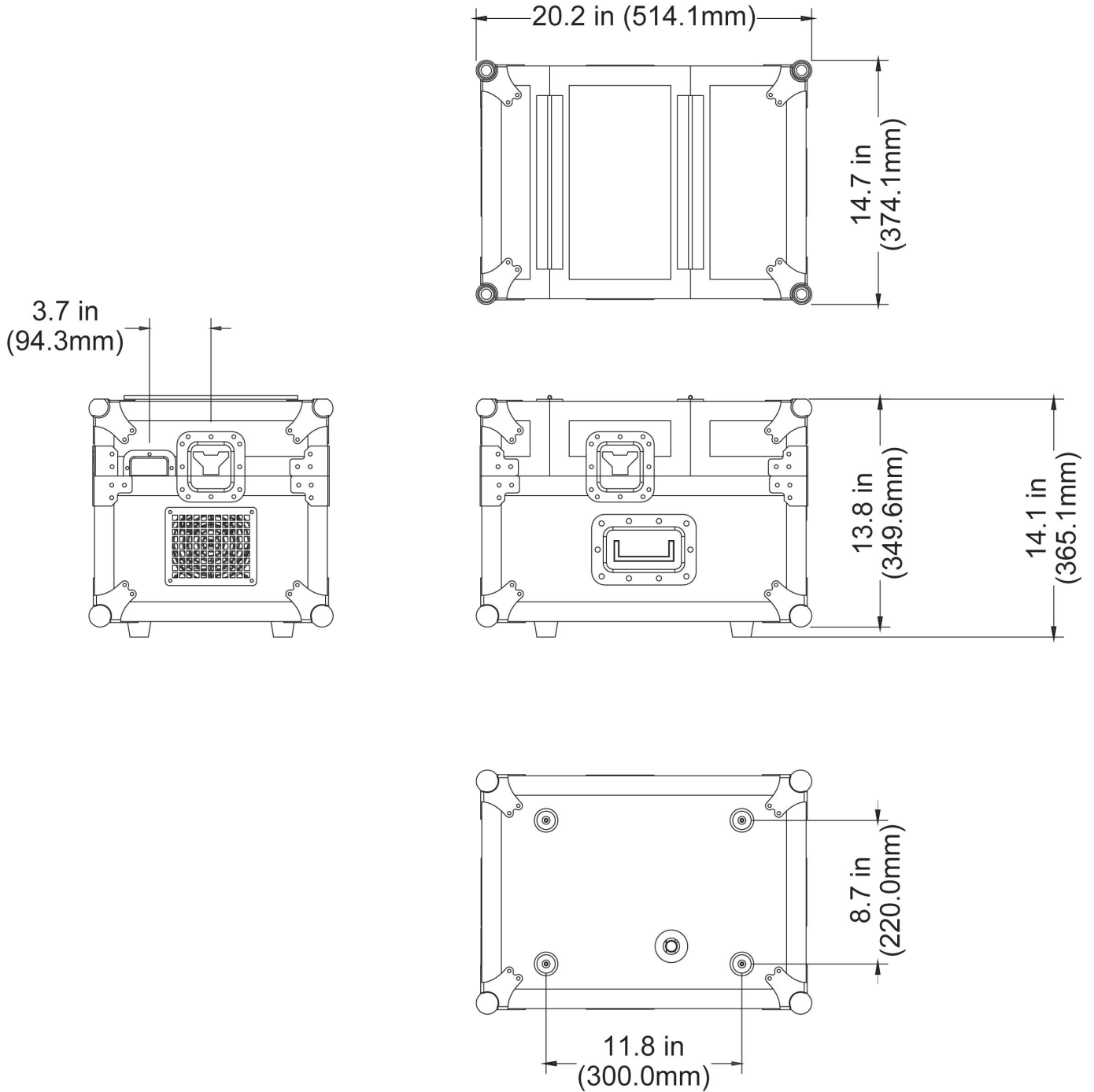

Dimensions may not be drawn to scale.

TROUBLE SHOOTING

If you experience low output, pump noise, or no output at all, disconnect the device and discontinue use immediately. Do not attempt to continue operation as this may damage the machine. Check the fluid level, the breaker, and the wall outlet to make sure that it is sending power. If all the above factors do not appear to be causing the issue, and the unit still fails to operate correctly, the unit will require service. Please contact Magmatic Effects for assistance.

CLEANING & MAINTENANCE

This device is capable of operating with either water-based or oil-based fluid. However, because the internal tank cannot be cleaned or disassembled, the following procedures must be followed when switching from one type of fluid to another:

- **WHEN GOING FROM OIL-BASED FLUID TO WATER-BASED FLUID-** Open the drain valve and allow the oil-based fluid to drain out completely, then fill the fluid reservoir with water. Run the device until the tank is completely empty, then refill the reservoir with water-based liquid. There may be traces of oil-based fluid left in the tank, but this will not affect the device.
- **WHEN GOING FROM WATER-BASED FLUID TO OIL-BASED FLUID -** Drain the water-based fluid from the tank, then leave the tank lid open and allow the tank to dry for approximately 24 hours. Close the drain valve, and fill the reservoir with oil-based fluid and run your device as desired.

When storing your device, be sure to store in a cool area. Cover the device to prevent dust from accumulating on the device. When storing for long periods of time it is highly advisable to run the device at least once every 3-4 months. Long periods of inactivity can severely shorten the life of your device. **Only run Magmatic's Atmosity fluid (SKU# ARH and AAH) through your machine.** Never run plain water, vinegar, or any other liquid solution through your device, as doing so will severely damage your device.

SPECIFICATIONS

PERFORMANCE

Rated Power: 370W
Max Output: 1,200 CFM* (cu ft/min.) (approximate)
Ready Time: Instant
Fluid Capacity: 0.66043 Gallons (2.5 liters)
Fluid Consumption: 0.033814 oz/min (1.0 ml/min)

COMPATIBLE FLUID

Atmosity ARH (Oil Based Fluid)
Atmosity AAH (Water Based Fluid)

CONSTRUCTION

Advanced HPA (high pressure air) Pump Technology
Energy Saving Mode with Auto-Clean Process
Sealed Fluid Reservoir
External Visual Fluid Level Detection
Compact Light Weight Mobile Design

CONTROL

DMX Control Modes: 2 (1 / 3 channel)
Onboard LCD Touch Control Panel
DMX-512 and RDM Protocol Support
Optional MAGFLY Wireless DMX Transceiver
Optional MAGRF Wireless and Wired Remotes

CONNECTIONS

Locking 5pin XLR Connector In/Out
IP65 Locking Power Connector In
With Wired Digital Communication Network

SIZE / WEIGHT

Length: 20.2 in. (514.1mm)
Width: 14.7 in. (374.1mm)
Height: 14.1 in. (365.1mm)
Weight: 66 lbs. (30kg)

ELECTRICAL

AC120V 60Hz (US Version)
AC230V 50Hz (EU Version)
10A Breaker (NFB US Version)
5A Breaker (NFB EU Version)
Max Power Consumption: 370W

THERMAL

Maximum Ambient Temperature (Ta max) 104°F (40°C)
Exterior Surface Temperature, Steady State: 122°F (50°C)

APPROVALS / RATINGS

CE | cETLus | IP20 | UKCA



This page intentionally left blank.

