

PixLite[®] A4-S Mk3

Pixel Controller



DATASHEET

KEY FEATURES

- 24 Universes of Art-Net or sACN
- 4 Powered Pixel Outputs
- Over 70+ Pixel Protocols Supported
- microSD Card Slot for Advatek SHOWTime™
- Dual Gigabit Ethernet Ports
- Auxiliary Port for DMX512 In/Out
- Configure Using Any Web Browser or Advatek Assistant 3 Software
- Smart Electronic Fuses on Pixel Outputs
- Electrical Fault Protection on All Ports
- Current Measuring on all Pixel Outputs

Made in Australia
5 Year Warranty

ADVATEK
LIGHTING



PixLite® A4-S Mk3

Pixel Controller

PRODUCT OVERVIEW

The **PixLite A4-S Mk3** is a powerful pixel LED controller built upon Advatek's 3rd generation PixLite Mk3 processor. The feature set of this processor are too significant to fit here, explore in the [PixLite Mk3 Processor Datasheet](#).

The **PixLite A4-S Mk3** drives up to 6 universes of data on each of its 4 outputs for a total of 24 universes of LED pixel control via its easily accessible and removable screw terminal blocks. Each pixel output handles a sizable current load and is fully equipped with Smart Electronic Fusing, so you'll never have to replace a fuse again.

A CLOSER LOOK AT THE CONTROLLER

DUAL GIGABIT ETHERNET PORTS

Simplify your network infrastructure by daisy chaining PixLite controllers together. Maintain high network reliability by optionally connecting a redundant Ethernet line to any loop with a suitable switch.

Ethernet ports are fully equipped with a Universe Data Hardware Firewall to ensure your PixLite can constantly perform at its peak.

SHOWTime

SHOWTime™ unleashes the potential of Advatek PixLite® Mk3 devices to independently drive light shows without a computer or any source of live data.

SHOWTime™ allows users to record and play back pixel shows from the PixLite A4-S Mk3 using the inbuilt microSD slot. Design your own breathtaking pixel shows, record them directly onto the microSD card and play them back as many times as you wish.

SHOWTime™ also unlocks the ability to create up to 25 powerful triggers and use advanced intensity controls to enable true standalone behavior and enhance live environments.

5 YEAR WARRANTY

For your absolute peace of mind, all Mk3 products come with a 5-year warranty. All products need to be used and installed in accordance with their designed purpose and operating environment. Please register your product on our website.

POWER MANAGEMENT

All pixel outputs are capable of up to 7A of pass through current and are equipped with Smart Electronic Fuses that will trip when over-current is detected, and automatically attempt to re-enable power output, removing the need to replace a physical fuse.

The solid aluminium base of the enclosure doubles as a heatsink, dissipating heat generated from high current installations and maintaining device integrity in high ambient temperatures.

AUXILIARY PORT

Versatile RS485 Auxiliary port can be used as either an input or an output.

As an output, connect DMX512 devices to the port and control them via sACN or Art-Net. As an input, connect a DMX512 source directly to the PixLite and use DMX512 as the data source for your pixels, or as a trigger source, or as a live intensity data source.

FAULT PROTECTION

Features electrical fault protection on all ports resulting in higher reliability and fewer equipment failures. See details on next page.

CERTIFICATIONS



PixLite® A4-S Mk3

Pixel Controller

SPECIFICATIONS

PHYSICAL

Ethernet Ports	2 x 10/100/1000 Mbit/s
microSD Card Slot	1
Auxiliary Port	1 x RS485 Input/Output
Pixel Outputs	4 x Powered
Dimensions (inc. connectors)	126.5 x 119 x 42mm
Weight	0.3kg
Enclosure	Aluminium + ABS
Mounting	Wall & Din-Rail Mountable

FAULT PROTECTION

Electrostatic Discharge (ESD)	All ports protected
Power Input	Reverse polarity protection
Auxiliary Port	+/- 48V DC fault protection
Pixel Output Clock/Data	+/- 36V DC fault protection
Pixel Output Power	Self-resetting over current and short circuit protection

CERTIFICATIONS & MARKS

North America	ETL Listing (Equivalent to UL Listing)
Europe	CE
North America	FCC
Canada	ICES3
Australia & New Zealand	RCM
United Kingdom	UKCA

PIXEL DATA

	EXPANDED MODE DISABLED / ENABLED	
Pixel Outputs	4	/ 8
RGB Pixels per Output	1020	/ 510
RGBW Pixels per Output	768	/ 384
Universes per Pixel Output	6	/ 3
Total Pixel Universes	24	/ 24

OVERALL DIMENSIONS

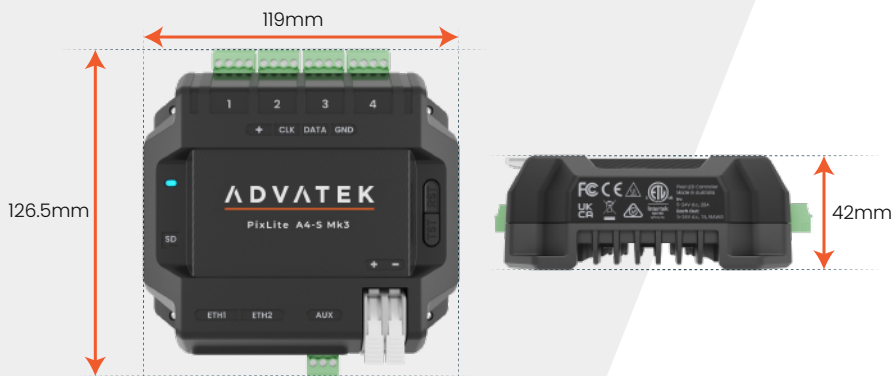

POWER

Input Power	5V - 24V DC
Per Output Current Limit	7A
Total Current Limit	28A

THERMAL

Storage Temperature	-20°C to +70°C
Ambient Operating Temperature	-20°C to +70°C

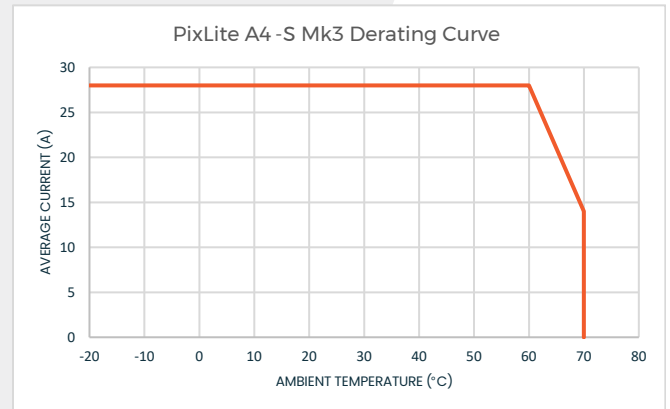

TESTING STANDARDS

Audio/Video & ICTE - Safety Requirements	UL 62368-1
Radiated & Conducted Emissions	EN 55032 & FCC Part 15
Multimedia Immunity	EN 55035
RoHS	RoHS 2 + DD (EU) 2015/863

INSTALLATION

Refer to installation instructions in the Product User Manual for acceptable use and storage requirements.

Standard	Indoors Only
With Conformal Coating	May be installed outdoors when installed inside a weatherproof enclosure

MOUNTING DIMENSIONS

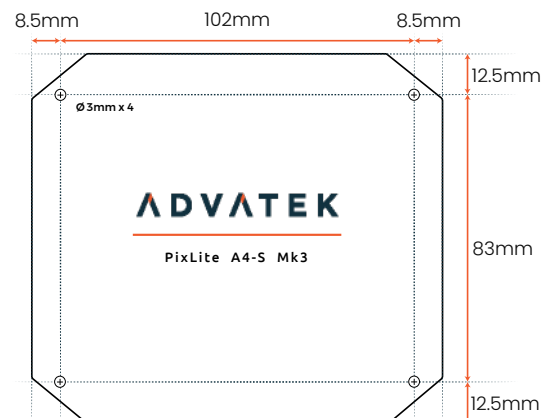

PixLite® A4-S Mk3

Pixel Controller

TYPICAL WIRING DIAGRAM

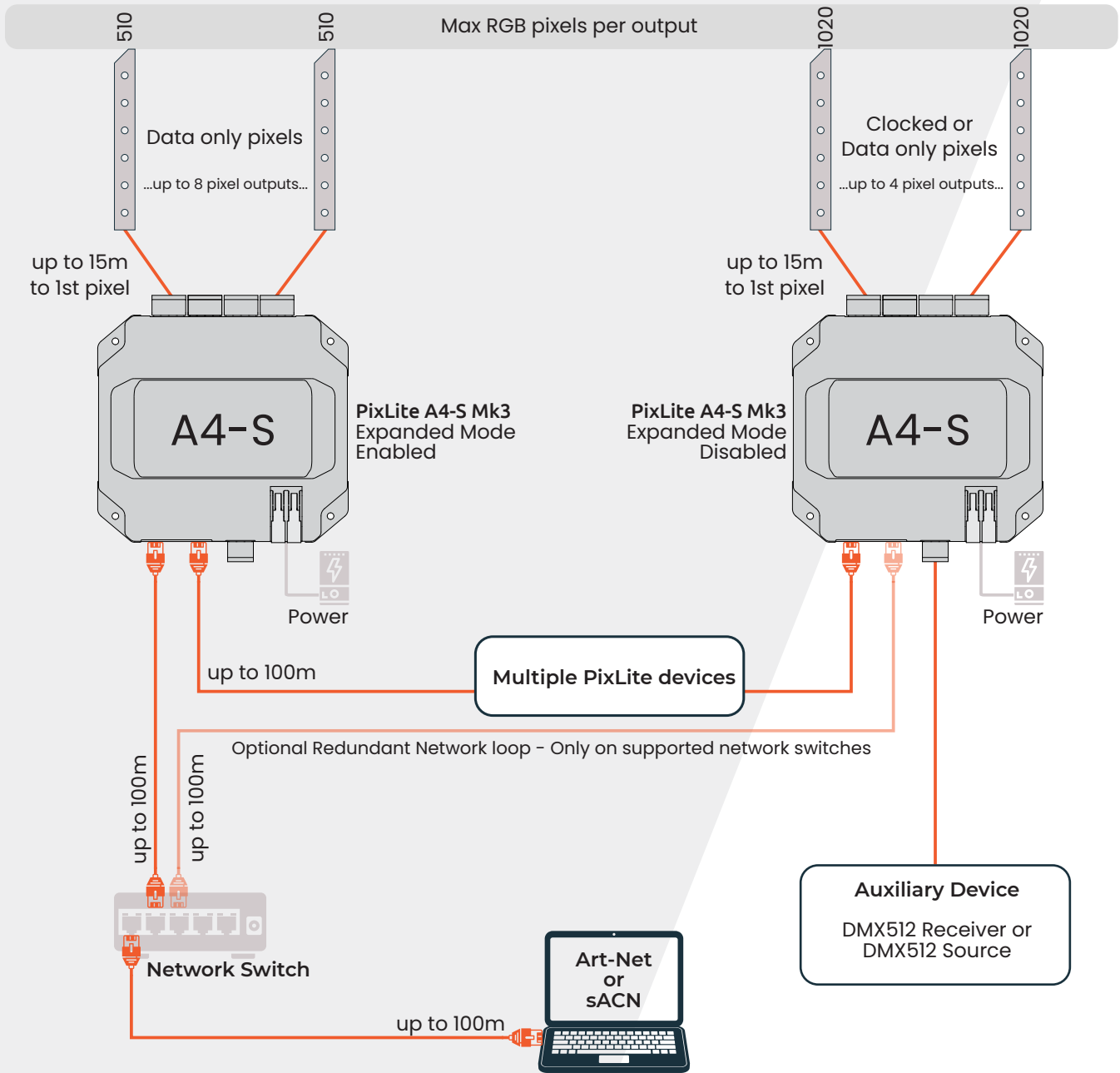

CONNECTIONS TO PIXELS

Pixels Clocked
Expanded Mode Disabled

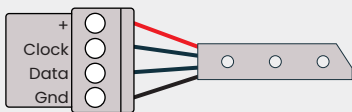

Pixels Data Only
Expanded Mode Disabled

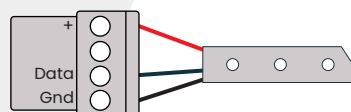

Pixels Data Only
Expanded Mode Enabled

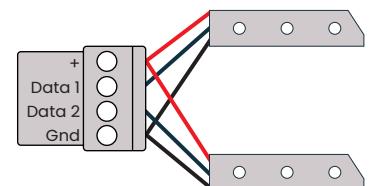

Pixels DMX512-D
Expanded Mode N/A

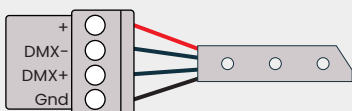

Pixels SK6822
Expanded Mode N/A

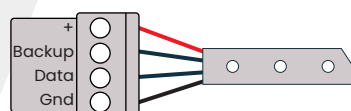

PixLite[®] A4-S Mk3

Pixel Controller

OPTIONAL ACCESSORIES

Din-Rail Mounting Bracket



ORDER CODES

PixLite A4-S Mk3	PIXA4S3
PixLite A4-S Mk3 with Conformal Coating	PIXA4S3-CC
Din-Rail Mounting Bracket	MNT0102